



PAKISTAN  
FOUNDRY ASSOCIATION  
PFA for Development of Foundry Industry

بِسْمِ اللَّهِ الرَّحْمَنِ الرَّحِيمِ





PAKISTAN  
FOUNDRY ASSOCIATION  
PFA for Development of Foundry Industry

# COMMERCIAL SESSION BY MARITIME INDUSTRY

## GUIDANCE FOR THE FOUNDRY INDUSTRY FOR THE PRODUCTION OF MARINE PRODUCTS



# SCHEME OF PRESENTATION



**PAKISTAN**  
FOUNDRY ASSOCIATION  
PFA for Development of Foundry Industry



**Introduction**



**Marine Foundry Products**



**Quality Challenges**



**Necessary Certifications**



**Commercial Challenges**



**Future Business at KS&EW**



**Conclusion**



# INTRODUCTION

- Foundries are integral to the manufacturing ecosystem
- Foundries are the backbone of modern manufacturing processes, indispensable in producing metal components that drive various industries
- Foundries are crucial in producing everything from automotive parts to aerospace components and construction materials
- There are a set of opportunities and challenges faced by the progression of foundries across the board

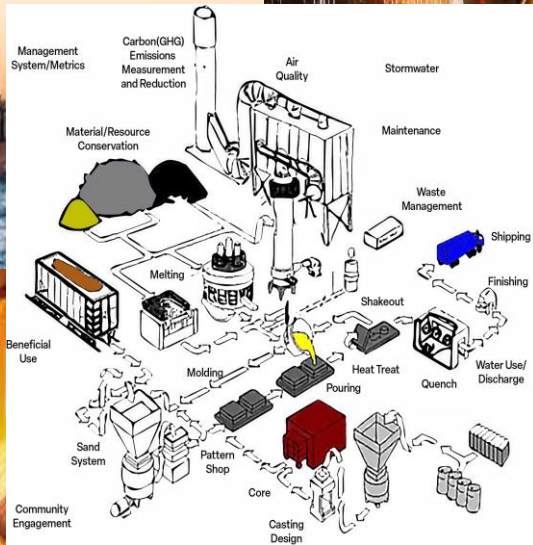

# INTRODUCTION

- **Technological Advancements:** Foundries must adopt new methods and equipment to stay competitive
- **Sustainability:** Foundries to minimize waste, lower energy consumption, and implement eco-friendly practices
- **Technological Innovations:** Advanced technology, such as 3D printing, designing, casting simulations, and automation, offers significant opportunities for the foundries
- **Market Demand:** By embracing technological advancements, foundries can meet the increasing local demands





# INTRODUCTION



**PAKISTAN**  
FOUNDRY ASSOCIATION  
PFA for Development of Foundry Industry

- The good news is that the govt is pursuing capability enhancement & fostering local shipbuilding vigorously
- All port authorities/ national shipping lines have been directed to meet vessel demand through local shipbuilding
- The foundry industry can support this Indigenous growth initiative by supplying quality castings
- The complex castings for maritime applications include several critical components for consideration

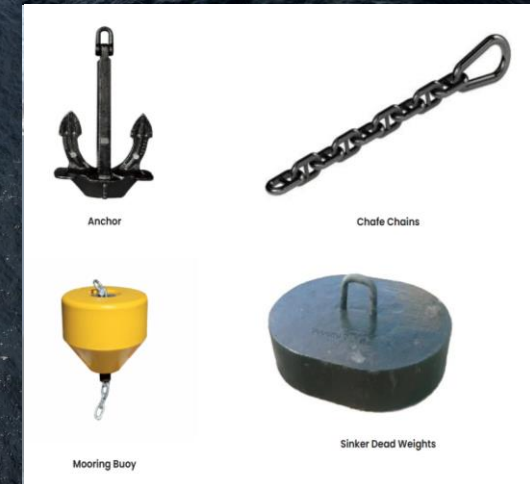

# Types of Foundry Products (Maritime Sector)

Here are some applications of foundry products in the maritime sector:

## Propulsion and Steering

- Propellers
- Propeller Hubs
- Rudder Stocks
- Steering Gear

## Hull and Superstructure

- Anchor Bolsters/Pockets
- Portholes

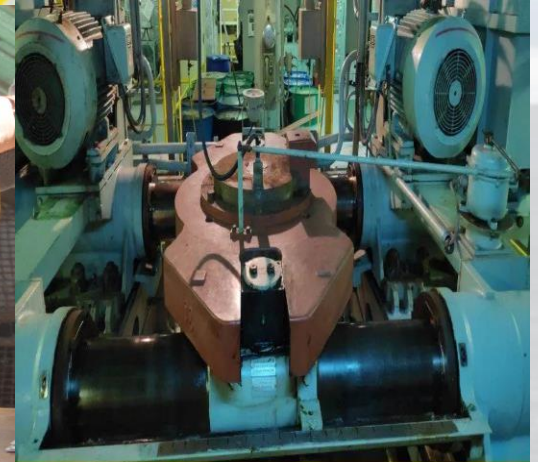
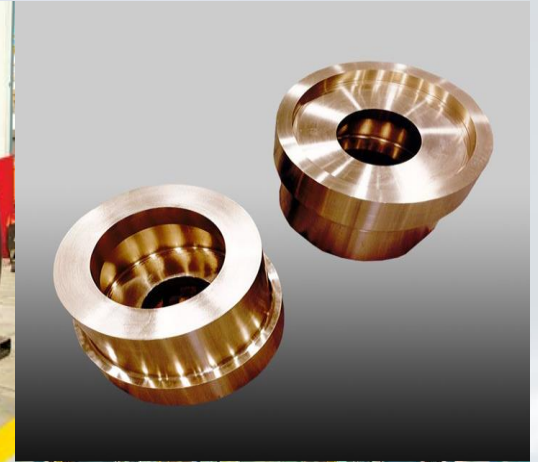

# Types of Foundry Products (Maritime Sector)

## Machinery and Equipment

- Pump Casings
- Valve Bodies

## Safety and Firefighting

- Fire Pump Casings
- Fire Hydrant Valves
- Safety Valves Bodies
- Relief Valves Bodies

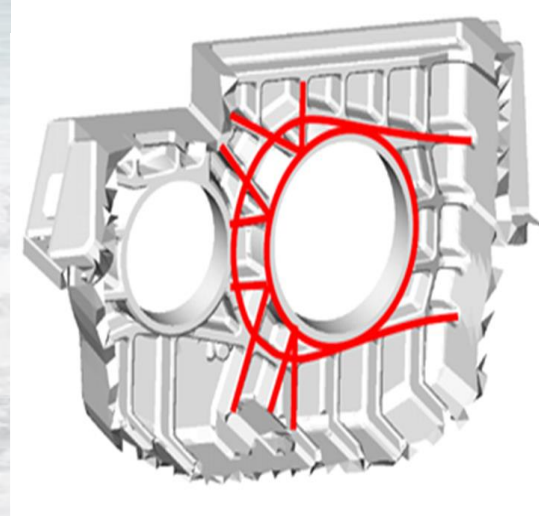





# Types of Foundry Products (Maritime Sector)



**PAKISTAN**  
FOUNDRY ASSOCIATION  
PFA for Development of Foundry Industry

## System Components

- Fair Leads
- Bearing Housings
- Mooring Eyes
- Mud Boxes
- Port Mooring Buoys Items

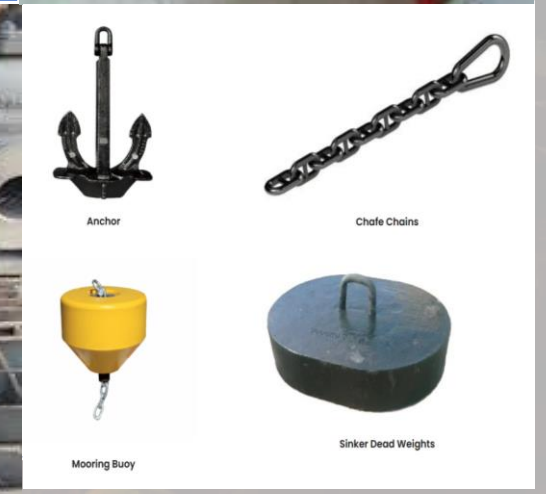

## Other Parts Produced Through Casting

- Bushes
- Sleeves
- Motor outer bodies and covers
- Metallic Ingot's Mold
- Pinion and Metallic wheels
- Custom castings



## M/s Byco Chain Stoppers

- KS&EW Foundry successfully cast and supplied 03 x chain stoppers under the BV 3<sup>RD</sup> Party Class Survey
- The desired material was ASTM Standard (A148 GR108-85) Cast steel
- It was a challenging task to get through the BV Class Survey for this product





# Quality Challenges in Maritime Foundry Sector



PAKISTAN  
FOUNDRY ASSOCIATION  
PFA for Development of Foundry Industry

- **High-strength, Corrosion-resistant materials:** Maritime applications require materials that can withstand harsh environments, corrosion, and high stresses
- **Complex Geometries & Designs:** Maritime components often have intricate designs, making casting & machining a challenge
- **Tight Tolerances & Dimensional Accuracy:** Maritime components require precise dimensions and tolerances to ensure proper fit and function.
- **Testing Required:** Chemical Composition Analysis, Mechanical Properties Testing (tensile or hardness), Non-Destructive Testing (MT, UT, LP, or RT ), Surface Finish Inspection in most standard casting specifications
- **Cyclic Loading Testing:** To prove a component to last for a certain life as desired test, cyclic loading of the component to decide through life



# Quality Challenges in Maritime Foundry Sector



PAKISTAN  
FOUNDRY ASSOCIATION  
PFA for Development of Foundry Industry

## Quality Inspections Certifications/Standards

- ISO 9001: 2015 Certified, 14001, 45001
- IACS Rules - Foundry and Process Approval for Castings
- ASNT Level III in RT, MT, & UT overseeing all NDT activities
- NDT Personnel qualified per ASNT SNT TC-1A
- ASME Welding Standards
- Radiography to ASTM E94, E1030, & E1742
- Wet and Dry Magnetic Particle Inspection to ASTM E709 & E1444
- Ultrasonic Testing to ASTM A609, DIN 12680-1 & -2
- Visual Surface Standards to MSS SP-55, & ASTM A802, SCRATA comp plates



# Necessary Certifications for Manufacturing



PAKISTAN  
FOUNDRY ASSOCIATION  
PFA for Development of Foundry Industry

## Certification and Regulatory Challenges

- **Material Certification and Traceability:** Foundries need to ensure raw material certification and traceability to ensure compliance with regulations
- **Class Survey for Equipment:** DNV GL: Det Norske Veritas Germanischer Lloyd standards, ABS: American Bureau of Shipping standards, LR: Lloyd's Register, BV: Bureau Veritas standards for maritime industry products



TÜRK LOYDU



BUREAU  
VERITAS



IACS International  
Association of  
Classification  
Societies



# Class Survey for Maritime Manufacturing



PAKISTAN  
FOUNDRY ASSOCIATION  
PFA for Development of Foundry Industry

NR216 DT R17 JANUARY 2025

## RULES ON MATERIALS AND WELDING FOR THE CLASSIFICATION OF MARINE UNITS

NR216 - JANUARY 2025



NR216

## RULE ON MATERIALS & WELDING FOR THE CLASSIFICATION OF MARINE UNITS

Chapter 1	General Requirements
Chapter 2	Testing Procedures for Materials
Chapter 3	Rolled Steel Plates, Sections and Bars
Chapter 4	Steel Pipes, Tubes and Fittings
Chapter 5	Steel Forgings
Chapter 6	Steel Castings
Chapter 7	Iron Castings
Chapter 8	Copper and Copper Alloys
Chapter 9	Aluminium Alloys
Chapter 10	Equipment for Mooring and Anchoring
Chapter 11	Type Approval of Welding Consumables
Chapter 12	Welding
Chapter 13	Other Products
Chapter 14	Advanced Non-Destructive Techniques



We have vast experience of catering to casting requirements under 3rd party inspections

## Foundries in India



PAKISTAN  
FOUNDRY ASSOCIATION  
PFA for Development of Foundry Industry

There are more than 5,000 foundry units in India

- Steel Authority of India Limited (SAIL)
- Bharat Forge Limited
- Kirloskar Brothers Limited
- Ashok Leyland
- Ramkrishna Forgings Ltd
- Tata Steel
- Sunflag Iron & Steel Company Limited





# Commercial Challenges in Maritime Sector



PAKISTAN  
FOUNDRY ASSOCIATION  
PFA for Development of Foundry Industry

## Production and Manufacturing Challenges

- **Low-volume, High-mix Production:** Maritime components are often produced in small quantities, making it challenging to achieve economies of scale
- **Long Lead Time:** Maritime projects often have extended lead times, requiring foundries to manage inventory and production schedules carefully
- **High Labor Costs:** Skilled labor is essential for producing high-quality marine components, increasing production costs
- **Global Supply Chain Complexities:** Maritime components often involve global supply chains, challenging logistics and coordination
- **Just-in-time Delivery Requirements:** Maritime repair requirements often require just-in-time delivery, putting pressure on foundries to manage production ASAP

# Future Business at KS&EW

- **JINNAH CLASS FRIGATE (up to 04 Ships)**
- **CONTAINER SHIPS (up to 04 Ships)**
- **FLEET TANKERS (up to 02 Ships)**
- **GUNBOATS (up to 19 Gun Boats)**





# Registering as a Vendor



PAKISTAN  
FOUNDRY ASSOCIATION  
PFA for Development of Foundry Industry

- Basic certifications like ISO 9001-2015, 45001, 14001
- Collaboration with any international foundry producing maritime products
- Readiness to meet the standards in the respective Class Survey Rules stipulated in their manuals
- Valid PEC Registration, NTN Certificate, Latest Equipment & Machinery





# Recommendations



PAKISTAN  
FOUNDRY ASSOCIATION  
PFA for Development of Foundry Industry

- PFA may put up relevant references related to maritime casting class surveyor rules on their website for guidance
- PFA may shortlist foundries interested in forming a cluster of maritime foundries for processing certification through any classification society
- Foundries may opt for selective products for the maritime sector & undertake R&D for local production and process approvals as necessary
- Foundries collaborate with the Maritime Sector to identify items to be produced
- Foundries may collaborate directly with the kit of material (KoM) suppliers for localization of items in line with the automobile sector



## Conclusion(s)



PAKISTAN  
FOUNDRY ASSOCIATION  
PFA for Development of Foundry Industry

- By embracing the opportunities, the local foundry industry can unlock the full potential of the maritime sector for sustainable Indigenous shipbuilding / maritime support
- By harnessing the power of local foundry products, the maritime sector can navigate the complexities of modern shipping and it can help to stay ahead of the curve
- The strategic adoption of local foundry products can play a critical role in the maritime industry's transition to a more sustainable future & improving operational efficiency
- The effective use of local foundry products can help backward integration of the shipbuilding/maritime sector supply chain in Pakistan



# Road Map for Maritime Foundry Business



**PAKISTAN**  
FOUNDRY ASSOCIATION  
PFA for Development of Foundry Industry

## First Phase: Planning and Development (2025-2027)

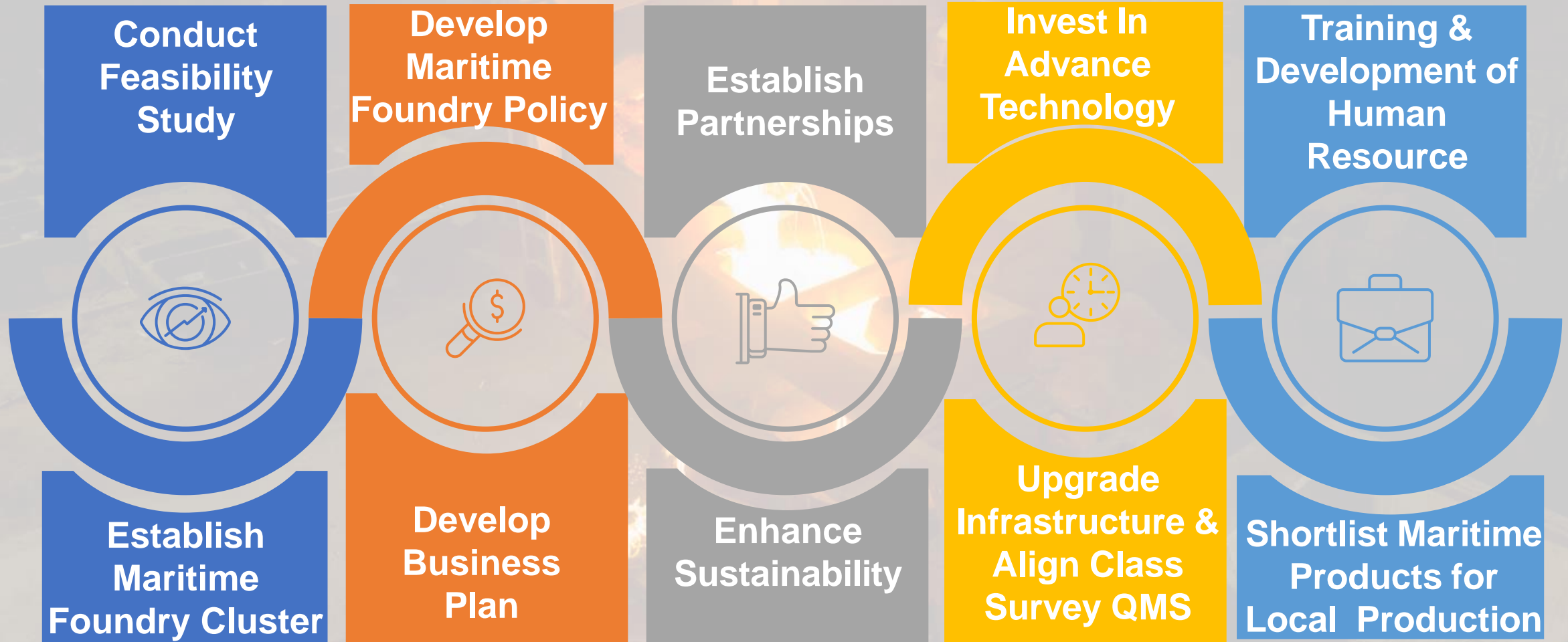



# Road Map for Maritime Foundry Business



**PAKISTAN**  
FOUNDRY ASSOCIATION  
PFA for Development of Foundry Industry

## First Phase: Planning and Development (2025-2027)



**PAKISTAN**  
FOUNDRY ASSOCIATION  
PFA for Development of Foundry Industry



# Road Map for Maritime Foundry Business



**PAKISTAN**  
FOUNDRY ASSOCIATION  
PFA for Development of Foundry Industry

## First Phase: Planning and Development (2025-2027)

**KARACHI SHIPYARD & ENGINEERING WORKS LIMITED**

*Serving the Nation Since 1956*  
**Pioneers in the Maritime Foundry Work**

**Password: KSEWIFCE**

**KSEW Corporate Profile**

**General Engineering Profile**

**Guidance For Maritime Foundry**

**KARACHI SHIPYARD & ENGINEERING WORKS LIMITED**  
West Wharf, PN Dockyard Road, Karachi 74000  
Tel: +92-21-99-21-4045-64 (20 Lines)  
Fax: +92-21-99214020, 99214030  
@Shipyardskarachi  
youtube.com Karachi Shipyards Official



**PAKISTAN**  
FOUNDRY ASSOCIATION  
PFA for Development of Foundry Industry





**PAKISTAN**  
FOUNDRY ASSOCIATION  
PFA for Development of Foundry Industry



**We Thank You For Overwhelming Interest Shown**



# Abstract



**PAKISTAN**  
FOUNDRY ASSOCIATION  
PFA for Development of Foundry Industry

## Title: Application of Foundry in Pakistan's Maritime Sector

- Pakistan's marine sector is experiencing significant growth, driven by increasing demand for shipbuilding and repair services
- The foundry industry is critical in supporting this growth by supplying high-quality castings for marine applications
- Despite these challenges, the foundry industry has significant potential for growth, driven by government initiatives to promote the marine sector and increasing demand for shipbuilding and repair services
- The study concludes that the application of foundry in Pakistan's marine sector can enhance economic growth and development
- By addressing challenges related to quality control and technology, and leveraging government initiatives, Pakistani foundries can enhance their capabilities and contribute to the growth of the Maritime Sector



# ICAS MEMBERS



**PAKISTAN**  
FOUNDRY ASSOCIATION  
PFA for Development of Foundry Industry

☰ of February 2024, the members of IACS are:<sup>[11]</sup>

Name	Abbreviation	Formed	Head office
American Bureau of Shipping	ABS	1862	Houston
Bureau Veritas	BV	1828	Paris
Croatian Register of Shipping	CRS	1949	Split
China Classification Society	CCS	1956	Beijing
DNV	DNV	1864	Oslo
Indian Register of Shipping	IRClass	1975	Mumbai
Lloyd's Register	LR	1760	London
Korean Register of Shipping	KR	1960	Busan
Nippon Kaiji Kyokai	ClassNK	1899	Tokyo
Polish Register of Shipping	PRS	1936	Gdańsk
Registro Italiano Navale	RINA	1861	Genoa
Türk Loydu	TL	1962	Istanbul

